

ActivBoard

Promethean P1 Projector Alignment Guide
Adjustable, Fixed and Mount Systems



Contents

Image for alignment	2
Rotating the image (if serial number WEST-P12290001 or later this is not required)	3
Aspect ratio and final image	3
Identifying adjustment points	4
Sizing the image	4
Horizontal alignment	5
Levelling of Image	6
Final Alignment	7

Image for alignment



Rotating the image

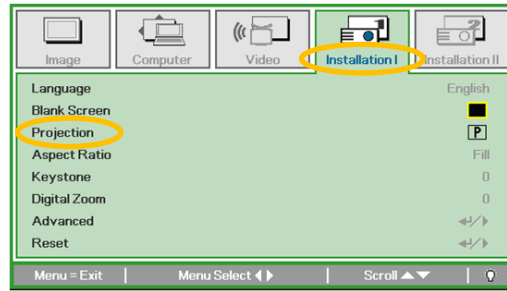

A x 1
C x 3
B x 3
C x 2
A x 2



Aspect ratio and final image

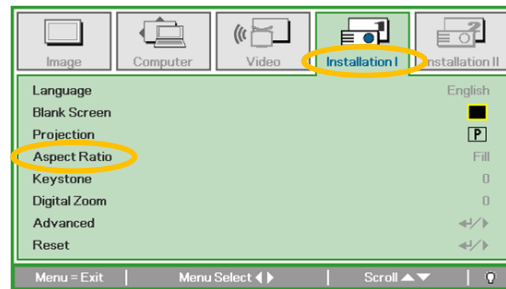

A x 1
C x 3
B x 4
C x 1
A x 2



A x 1
C x 3
B x 3
C x 2
A x 2

387/587 – Fill = Default



178/378/578" – 4:3



395/595" – 16:9



Identifying adjustment points

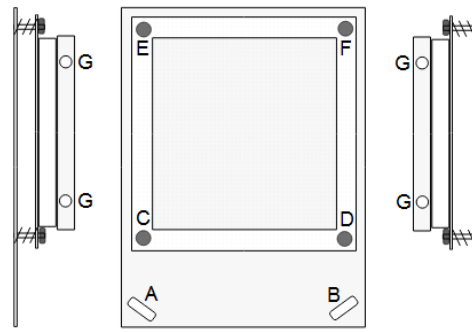
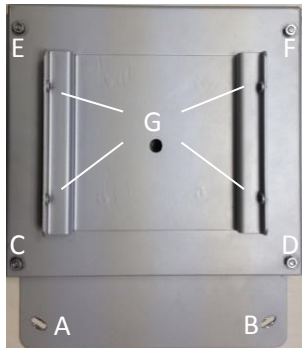

sizing the image

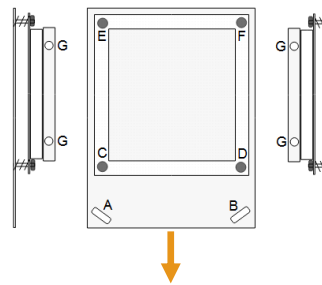
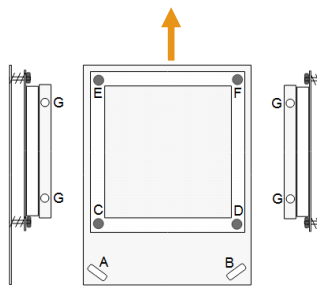

Horizontal Alignment

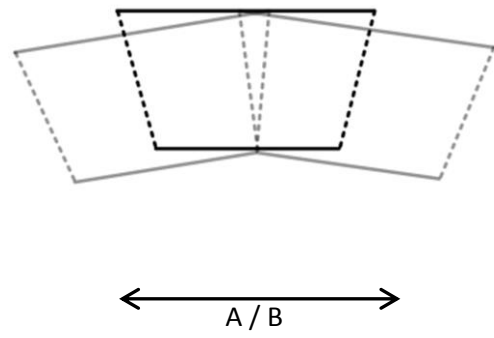
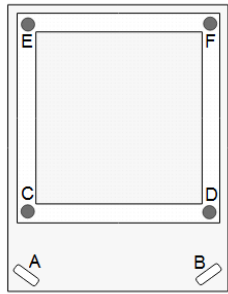

1



2



Levelling of Image

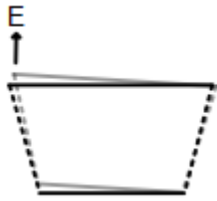
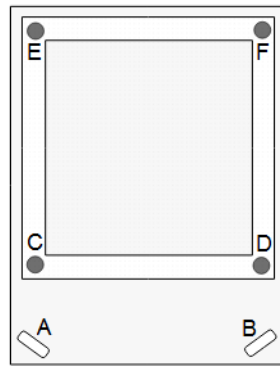

1

2

3



Final Alignment

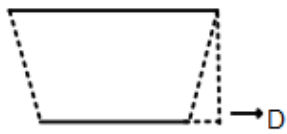
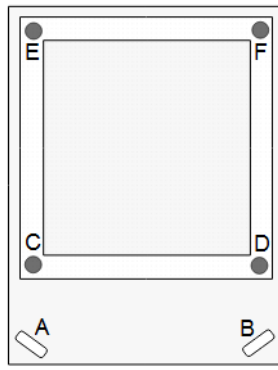

1



Final Alignment Cont'd

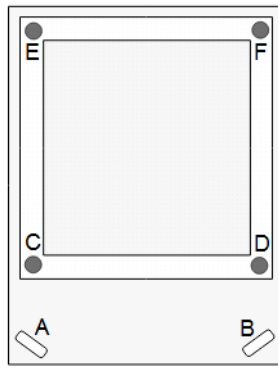

2

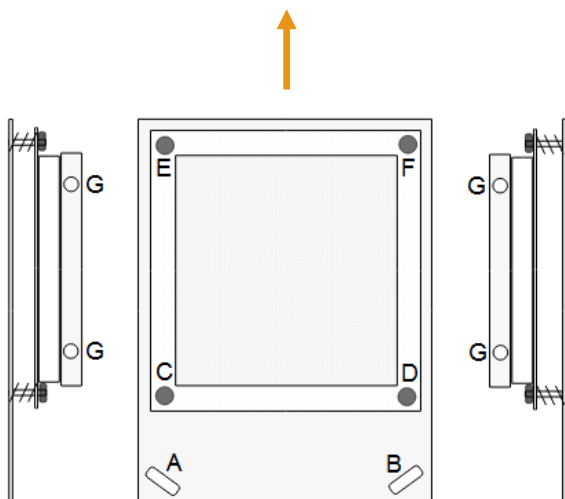

Final Alignment Cont'd

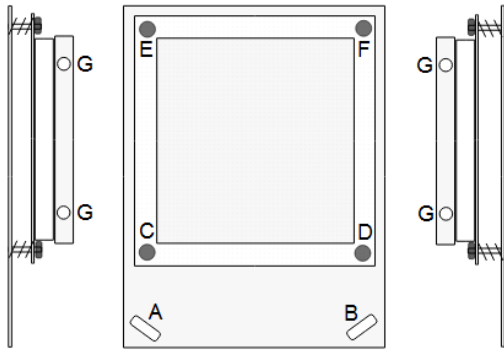

3

